

Owners Manual  
for

**TRAILER**  
**Buddy**<sup>®</sup>  
**AXLES BY LFF**

The VAULT “HLS”  
“Hybrid Lubrication System”

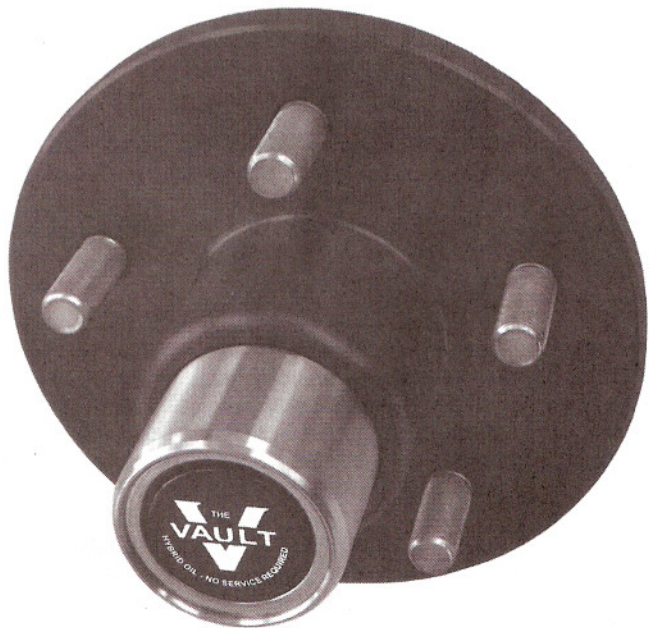

## **TRAILER BUDDY AXLE**

Your trailer is equipped with a Trailer Buddy Axle utilizing the VAULT bearing protector with specially formulated "Hybrid Oil". The VAULT combines the benefits of oil and grease, lubricating and protecting your wheel bearings in a sealed pressurized chamber impenetrable by outside elements.

This system has a number of unique features not found on conventional trailer axles. We take care to seal every possible leak point on the front and rear of the hub. UFP makes the finest quality axle assemblies available, which are designed for long term, trouble free performance. The following information is provided to answer questions you may have regarding this product.

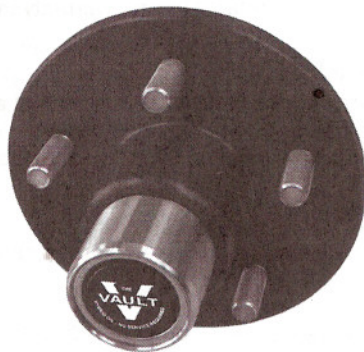

## **PRESSURIZED SYSTEM WON'T DAMAGE SEALS**

The slight (3-6 psi) pressure the VAULT system generates inside the hub chamber WILL NOT damage the inner oil seals. The pressure inside the hub is needed to keep water out of the hub chamber when the hub is submerged under water during boat launching and retrieval.

## **RECOMMENDED LUBRICANT**

There is no need for inspection or replenishment of the lubricant. The VAULT "Hybrid Lubrication System" uses proprietary Hybrid Oil specially designed by UFP. At ambient temperatures the oil is thick, with a viscosity approaching grease. As the bearing temperature rises during towing, the hybrid oil thins out, replenishing the bearings with lubricant and dissipating heat. For optimal performance, only UFP's hybrid oil should be used in this system.

## **ADDING / CHANGING HYBRID OIL**

Adding or changing the hybrid lubricant in the VAULT is not necessary or recommended for the first five years of service, or ten years with extended warranty. All warranty service must be pre-approved by UFP, or the claim will not be considered valid. After your warranty period expires, refer to the "SERVICE" section for additional instructions.

## **BEARING CHECK**

If the bearings need to be adjusted or replaced, you must contact UFP first. We will help diagnose the problem and send instructions to assure that the work is done correctly. Failure to contact UFP before the work is begun will void the warranty.

Wheel bearings have been precisely torque-set at the factory. To assure your bearings are in good working order, we suggest you check your bearing adjustment at least once a year by following this procedure. Jack up on side of the trailer (make sure you use jack stands and chock the trailer wheels to keep the trailer from moving). Grip the edge of the tire and see if you can rock or move it. If you can move the outer edge of the tire more than 1/8", your bearings may need to be re-adjusted. Contact UFP for warranty instructions.

## **OIL LEAKAGE AT REAR SEAL**

A slight amount of oil seepage at the rear seal is normal and necessary to lubricate the wiper lip of the seal for long life and sealing contaminants out. If excessive leakage is occurring, contact UFP for instructions.

## **WHAT ELSE TO CHECK**

As a minimum general rule, before towing any trailer, make sure to at least check the following items on the trailer:

- Check cold tire pressures. Improperly inflated tires can cause catastrophic tire failure
- Make sure the trailer is level to the ground with both trailer and tow vehicle loaded with gear.
- Make sure your wheel lug nuts are tight. Wheel lug nuts should be tightened to a specific torque using a torque wrench (see your owners manual). Never use an impact wrench to tighten lug nuts.
- Be sure the coupler is secured. As insurance, insert the safety hitch pin or other locking device into the hole in the coupler to be sure it is properly latched and won't accidentally pop open.
- Be sure the trailer jack is raised and locked in place. Check that the trailer wiring is properly hooked up and working.
- Be sure the safety chains (or cables) and emergency brake cable (if equipped) are in place and properly secured so they won't fall off.

## **SERVICE**

The VAULT does not usually require any service. If you believe service is required, you must contact UFP prior to performing any work that would be covered under warranty.



## BEARING ADJUSTMENT

This procedure is to only be performed if bearing adjustment is deemed necessary after performing the bearing check procedure described in "BEARING CHECK" section.

Remove the VAULT wheel bearing protector. The protector is held in the hub by an interference fit. To remove cap, lay a block of wood against the side of it and strike the wood with a hammer. Place the wood on the opposite side and hit it again. Continue this procedure until you slowly "walk" the cap out of the hub. Remove the cotter pin and spindle nut retainer.

While rotating hub, tighten the spindle nut to 18-20 inch-pounds, which is about "finger tight." Do not over tighten. When the unit is positioned properly the wheel should turn easily and there should be no end-play (lateral movement) of the hub in respect to the spindle.

To replace the nut retainer, find a position where it will fit over the spindle nut at so that the cotter pin can be inserted without having to loosen or tighten the nut. Insert a new cotter pin. Recheck end-play. Spread the ends of the cotter pin to keep it in place.

Make sure the rubber o-ring is installed in the nose of the hub. Clean the bore of the hub cavity thoroughly. Add hybrid oil to the inside of the VAULT protector. Apply a thin film of Permatex High-Temp RTV Silicone Gasket Maker to the bore surface. Install the protector with a soft mallet until the shoulder seats against the hub nose.

## BEARINGS

We use tapered roller bearings identical to those currently being used on many automobiles. Replacements are readily available.

Axle Load Capacity	Inner		Outer	
	Cone	Cup	Cone	Cup
1500# -2500#	L44649	L44610	L44649	L44610
2900# -3750#	L68149	L68110	L44649	L44610
4200#	L68149	L68110	L68149	L68110
5200# (6 Bolt) 2.328"	25580	25520	LM67048	LM67010
5200# (6 Bolt) 2.441"	25580	25520	15123	15245
6000# (8 Bolt) 2.717"	25580	25520	1415A	14276

## OIL SEALS

Each hub has a rear (inner) seal which keeps oil from leaking out of the back of the hub. The spring-loaded seals used on your axle are the best available for the application. The axle spindles are equipped with permanent, polished stainless steel seal surfaces for the seals to rotate on. This system should provide many years of use before seals need to be replaced.

## REPLACEMENT PARTS

Please contact UFP for certified replacement parts. Although some parts look identical or have the same description, they may not have the quality or dimensional tolerances needed to assure trouble free operation and optimum performance.

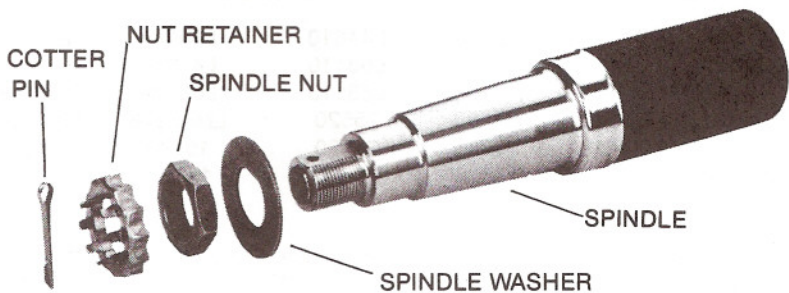
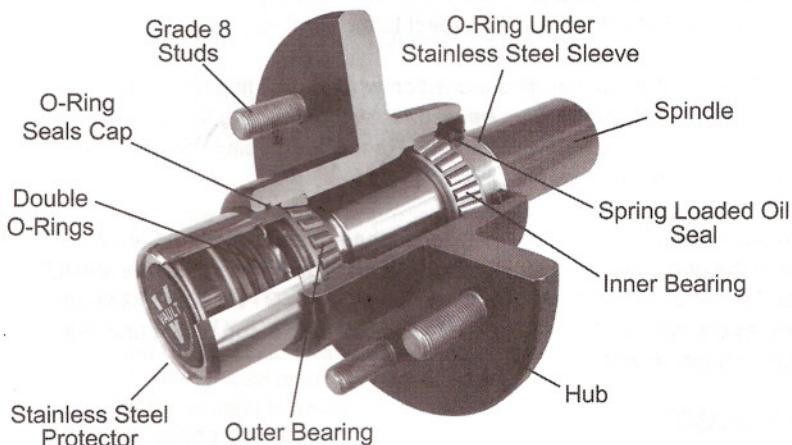

## REPLACING SEALS

The hub or rotor must be removed from the axle and the seal forced out. It is impossible to remove the seal without damaging it. So, when you remove it, plan on replacing it. Because seals are a high quality design not widely available, you will have to obtain a replacement from the dealer, a bearing supply company, the trailer manufacturer or Unique Functional Products. Seals installed at the factory may have a Hypalon coating on the outside diameter. If you replace seals without Hypalon apply a thin film of Permatex High-Temp RTV Silicone Gasket Maker on the seal outside diameter and hub bore prior to installation.

Seals currently in use are:

<b>Axle Load Capacity</b>	<b>Seal Outer &amp; Inner Diameter</b>	<b>Inner Bearing Cone</b>
1500# -2500#	1.98" x 1.38"	L44649
2900# -4200#	2.33" x 1.68" or 2.56" x 1.68"	L68149 L68149
5200# (6 Bolt)	3.38" x 2.13" or 3.26" x 2.13"	25580
5200# (8 Bolt)	3.38" x 2.13"	25580

## SEAL CONVERSION INFORMATION

### Replacement Part Numbers

<b>Seal Description</b>	<b>Trailer Buddy</b>	<b>NOK</b>	<b>CR</b>	<b>National</b>
198-138-SP1-1	07026	AB1990EO	13557	482163N
233-168-SP2-1	07027	AD2527EO	16657	473317
256-168-SP2-1	07028	AD2528EO	_____	_____
326-213-SP2-1	07029	AD7131EO	_____	_____
338-213-SP2-1	07040	AD8717EO	21352	_____

## WHEEL BOLTS (OR CONE NUTS)

If you remove a wheel from a hub it is very important to properly tighten the wheel bolts when you reinstall the wheel.

Mount the wheel on the hub and start the wheel bolts into the hub as far as possible by hand. Then, using a proper lug wrench, tighten each wheel bolt moderately tight. Work your way around the wheel, tightening the bolts per diagram below until all bolts have been tightened. Then work your way around the wheel again, using the same bolt tightening sequence, and tighten each bolt to torque recommended by the trailer manufacturer.

It is important that the wheel be centered on the hub. The wheel may reseal itself slightly during the first miles of travel after installation. After 100-200 miles of travel, check wheel bolt tightness. Check periodically thereafter.

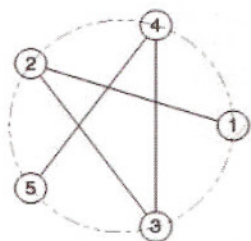

5 LUG BOLT  
PATTERN

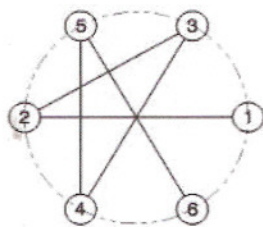

6 LUG BOLT  
PATTERN

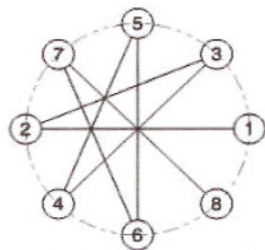

8 LUG BOLT  
PATTERN

## THE VAULT EXTENDED LIMITED WARRANTY OPTION CARD

### ORIGINAL OWNER CONTACT INFORMATION:

OWNER'S NAME: \_\_\_\_\_  
OWNER'S STREET ADDRESS: \_\_\_\_\_ CITY/STATE/ZIP: \_\_\_\_\_  
OWNER'S PHONE: \_\_\_\_\_ E-MAIL: \_\_\_\_\_  
DEALER NAME: \_\_\_\_\_ DEALER CITY/STATE: \_\_\_\_\_

### TRAILER INFORMATION:

TRAILER MANUFACTURER \_\_\_\_\_ TRAILER GVWR (Gross Vehicle Weight Rating) \_\_\_\_\_  
DATE BUILT: \_\_\_\_/\_\_\_\_/\_\_\_\_ VIN # \_\_\_\_\_ DATE OF PURCHASE \_\_\_\_/\_\_\_\_/\_\_\_\_  
AXLE SERIAL #'s (LOCATED ON A METAL PLATE ON THE BOTTOM OF EACH AXLE) \_\_\_\_\_, \_\_\_\_\_, \_\_\_\_\_

FOR EXTENDED LIMITED WARRANTY ON THE VAULT AXLE, SEND THIS CARD WITH CREDIT CARD INFORMATION, CHECK OR MONEY ORDER IN THE AMOUNT OF \$50.00 USD TO:

UFP, 1041 Baxter Lane, Winchester, TN. 37398, Fax# 931-967-1828

OR

UFP, 135 Sunshine Lane, San Marcos, CA. 92069, Fax# 760-744-4709

OR

Call UFP at 800-835-9211 Ext.16

Credit Card number \_\_\_\_\_ Visa \_\_\_\_\_ Master Card \_\_\_\_\_

Signature \_\_\_\_\_ Expiration Date \_\_\_\_\_

EXTENDED LIMITED WARRANTIES MUST BE PURCHASED WITHIN ONE YEAR OF START OF ORIGINAL WARRANTY.



## TRAILER BUDDY AXLE WITH THE VAULT "HLS" LIMITED WARRANTY

Original Limited Warranty - Trailer Buddy Axles, with the VAULT, are guaranteed against bearing failure and against defects in materials or workmanship under normal use for a period of five years. The original owner can purchase an additional five-year, Extended Limited Warranty from UFP within the first year of ownership.

In cases of resale, any remaining Original Limited Warranty may be transferred to subsequent owners.

An Extended Limited Warranty registration form is supplied in this Owners Manual and comes along with every new trailer. This form allows the original owner to purchase the Extended Limited Warranty option.

### When It Begins

The Original Limited Warranty begins on either of the following dates; whichever is earlier:

The date the original owner takes delivery of the trailer; or

The date the trailer was first put into service – for example, as a dealer "demo" or as a Trailer factory "demo."

The Extended Limited Warranty begins the date your trailer has been in service for more than 60 months and cannot be transferred to subsequent owners/purchasers.

### When It Ends

The Original Limited Warranty extends to the trailer owner and lasts for 60 months from the date it begins.

The Extended Limited Warranty extends to the original owner and lasts for 60 months from the date it begins.

### Warranty Transfer Option

**Transferable option:** Any remaining Original Limited Warranty may be transferred to subsequent owners/purchasers.

The Extended Limited Warranty is not transferable to subsequent owners/purchasers.

Contact UFP for details and Extended Limited Warranty.

Any Original Warranty transferred pursuant to this section does not extend the length of the original warranty.

### Use of Vehicle Identification Number (VIN) and Axle Serial Number.

The VIN is a 17 digit number located on the trailer identification label on the left side of the trailer. The axle serial number is located on a metal tag on the axle beam. The axle serial number gives us the most complete information on your axle. Be sure to include the VIN, Trailer Date of Manufacture, and Axle Serial Number(s) in all communications with UFP.

# LIMITED WARRANTY (Continued)

## Limitations of Coverage

This warranty does not cover:

- Damage caused by accidents, road hazards, overload, or modification of products.
- Failure attributable to improper assembly of, or damage to components if hub is removed from axle spindle.
- Damage caused by use of wheels not supplied by trailer manufacturer.
- Damage caused by overheated brakes or worn brake pads.

Braking components are covered under a separate warranty.

This warranty is limited to defective parts replacement only. Charges for installing replacement parts, damage incurred to other equipment as well as accidental or consequential damages connected therewith are excluded. Some states do not allow the exclusion or limitation of incidental or consequential damages, so the above limitations may not apply to you.

## Repair or Replacement Procedure

If a failure or defect occurs during the warranty period, promptly contact warrantor's (UFP) customer service department. Until such notice is received, UFP will not be responsible for any repair or replacement costs. UFP, at its option, may require return of the axle assembly or the component in question to the factory, transportation charges prepaid. UFP will replace; FREE OF CHARGE, either the entire axle assembly or the part that proves defective, at its option. Any part found not to be defective will be returned freight collect with an explanation.

## Purchaser's Rights

This warranty gives you specific legal rights, and you may also have other rights, which vary, from state to state.

## Product Improvement

UFP has a policy of continuous product improvement. We reserve the right to change or improve the design of our products without assuming any obligation to modify any product previously manufactured.



135 Sunshine Lane ★ San Marcos, CA 92069  
(760) 744-1610 ★ Fax (760) 744-1616 ★ [www.ufpnet.com](http://www.ufpnet.com)